

**AnyTone<sup>®</sup>**  
*We only do best radio!*

**Qixiang Electron Science & Technology Co., Ltd.**  
[www.qxdz.cn](http://www.qxdz.cn)

# AnyTone®



ISO 9001  
ISO 14001



## AT-3318UV

DUAL BAND HANDHELD RADIO

FC CE !



INSTRUCTION MANUAL



## THANK YOU!

*AnyTone*<sup>®</sup> transceiver will provide you with reliable, clear and efficient communication service. The transceiver introduces innovative DSP digital signal processing technology, high degree integration, it is including kinds of professional function, best stability and great reliability as well as exterior smooth lines, novel, fashionable, sturdy and durable.

The transceiver includes plenty of TX, RX channels, as well as UU,VV and UV standby modes which are able to realize dual PTT functions. 51 groups of CTCSS encode/decode and 1 group of user-defined CTCSS encode/decode, 1024 groups of DCS encode/decode, 5TONE/2TONE/DTMF encode/decode, built-in radio functions, etc..It is a meticulous build functional and Multi frequency band radio for radio amateur and commercial users.

### Versions

Version A: Dual frequency, dual standby, dual display, dual band, single receive channel.

## MODELS APPLY TO THIS MANUAL

AT-3318UV FM transceiver

AT-3318UV(Version A) programming software: QPS3318UV\_USA

## PROGRAM CAUTIONS

When programming the transceiver, **read the factory initial data first**, then rewrite the frequency and signaling etc., other wise errors may occur because of different frequency ranges involved.

## CAUTIONS

*AnyTone*<sup>®</sup> transceiver is excellent designed with advanced technology. The following tips will be helpful for you in performing your obligation under warranty and understanding the safety of transceiver usage.

- 1.Keep the transceiver and accessories away from children.
- 2.Please do not try to open or modify the transceiver without permission, non-professionals operation may also cause damage.
- 3.Please use assorted battery and charger to avoid damage.
- 4.Please use assorted antenna to ensure the communication distance.
- 5.Please avoid exposing the radio under the sunshine for a long time or storing it in too hot places. High temperature will shorten the life of electronic devices.
- 6.Please avoid storing the radio in the dusty, dirty and damp areas.
- 7.Please keep the radio dry. Do not wash radio with ardent chemicals and detergents.
- 8.Do not transmit without antenna.
- 9.When using this transceiver, we recommend transmitting for 1 minute then receiving for 4 minutes. continuously transmitting for long time or working in high power will heat the back of the transceiver. Do not place the transceiver's hot back close to any plastics.
- 10.If any abnormal smell or smoke coming from the transceiver, please turn off the power instantly and take off the battery and its case. Then contact local *AnyTone*<sup>®</sup> dealers.

### NOTE:

All the above tips apply for your *AnyTone*<sup>®</sup> transceivers' accessories. If any device can not operate normally, please contact with local *AnyTone*<sup>®</sup> dealers.

If you use any accessories made by other companies, *AnyTone*<sup>®</sup> company does not guarantee the operability and safety of the transceiver.

## ◦ TABLE OF CONTENTS



<b>UNPACKING</b> .....	01
Supplied Accessories .....	01
<b>STANDARD ACCESSORIES/ADDITIONAL ACCESSORIES</b> .....	02
Standard Accessories.....	02
Additional Accessories.....	02
<b>OPERATION MODE (AMATEUR TRANSCEIVER OR PROFESSIONAL TRANSCEIVER)</b> .....	03
<b>WORKING MODE (AMATEUR TRANSCEIVER OR PROFESSIONAL TRANSCEIVER)</b> .....	04
<b>BATTERY INFORMATION</b> .....	05
Charging Operation .....	05
Battery Charger Type.....	05
Notice for Charging Battery .....	05
How to Charge.....	06
Charging Prompt.....	08
How to Store the Battery.....	08
<b>INSTALLATION &amp; CONNECTION</b> .....	09
Installing / Removing the Li-ion Battery.....	09
Installing / Removing the Antenna.....	10
Installing / Removing the Belt Clip .....	10
Installing Optional Speaker / Microphone.....	11
<b>GETTING ACQUAINTED</b> .....	12
LCD Display .....	12
<b>BASIC OPERATIONS</b> .....	15
Turn the Radio On & OFF .....	15
Adjusting Volume.....	15
Switch between Main band and Sub band .....	16

## ○ TABLE OF CONTENTS

Switch between Channel mode and VFO mode .....	16
Channel Adjusting .....	16
Frequency Adjusting.....	16
Frequency Input by Keypad .....	17
Channel Input by Keypad .....	17
Squelch Off Momentary / Squelch Off.....	18
Receiving .....	18
Transmitting.....	18
Emergency Alarm .....	19
Side Key [PF1] function instruction.....	19
Side key [PF2] function instruction.....	20
Edit channel.....	20
Delete channel.....	20
Programming scan.....	21
<b>SHORTCUT OPERATIONS .....</b>	<b>22</b>
Add/Cancel Optional signal decode function.....	22
CTCSS/DCS Scan .....	22
Offset Frequency Direction Setup .....	23
Frequency/Channel Scan.....	23
Channel Scan Skip .....	24
Frequency Reverse.....	24
TX Power selection.....	25
Stopwatch function.....	25
DTMF code Transmit and Enquiry .....	25
Keypad lock.....	26
Single-band Switching.....	27

## ◦ TABLE OF CONTENTS



CTCSS/DCS Encode and Decode.....	27
<b>Function Menu Setup</b> .....	28
CTCSS/DCS Encode Setup.....	28
CTCSS/DCS Decode Setup.....	29
CTCSS/DCS Encode / Decode Synchronous Setup.....	29
5TONE Encode Group Selection.....	30
2TONE Encode Group Selection.....	31
Optional Signaling Setup.....	31
Squelch mode Setup.....	32
Frequency Step Size Setup.....	33
Wide / Narrow Band Selection.....	33
Frequency Reverse.....	34
Talk Around ON/OFF.....	34
Offset Frequency Setup.....	35
Editing Channel Name.....	35
Busy Channel Lockout.....	35
TX OFF.....	36
Band Limit.....	37
Sub Band Display Setup.....	37
Keypad Voice Prompt Setup.....	38
Time-Out-Timer (TOT).....	38
Voice Operated Transmission (VOX) Setup.....	39
VOX Delay Setup.....	39
Automatic Power Off Time Setup.....	40
DTMF Transmitting Time Setup.....	40
Squelch level Setup.....	41



## ○ TABLE OF CONTENTS

Scan Dwell Time Setup .....	41
Function Icon Stay Time Setup.....	42
LCD Backlight Setup.....	42
LCD Backlight Color Setup.....	43
Self ID Inquiry.....	43
Tone Pulse Frequency Selection .....	44
Battery Save Setup.....	44
FM Radio .....	45
FM Radio Functions.....	45
PF1 key Function Setup.....	46
<b>Senior Function Operations</b> .....	47
Display Mode Setup.....	47
Resume Factory Default.....	47
Cloning Cable.....	48
<b>Memory Bank</b> .....	50
Memory Channel Mode .....	50
Memory Bank Switch.....	50
Memory Bank Exit.....	50
Bank Linking.....	51
<b>Programming software starting (Takes Windows XP system for example)</b> .....	52
<b>TECHNICAL SPECIFICATION</b> .....	53
<b>TROUBLE SHOOTING GUIDE</b> .....	54
<b>ATTACHED CHART</b> .....	56
CTCSS Frequency Chart.....	56
1024 groups DCS Frequency Chart.....	57

## ○ UNPACKING



Please carefully unpack the transceiver. We recommend that you identify the items listed in the following table before discarding the packing material.

If any items are missing or have been damaged during shipment, please contact with dealers immediately.

### Supplied Accessories

Item	Number	Quantity
Antenna	QA09UV2	1
Li-ion Battery	QB-26L	1
Battery Charger	QBC-26L	1
AC Adaptor	QPS-01	1
Belt Clip	BC01	1
Hand Strap	GS01	1
Instruction Manual		1
Certificate		1

## STANDARD ACCESSORIES/ADDITIONAL ACCESSORIES

### Standard Accessories



Antenna\*1  
QA09UV1  
155/435MHz

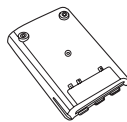

Li-ion Battery  
QB-26L(1500mAh)

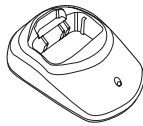

Battery Charger  
QBC-26L

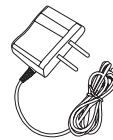

AC Adaptor  
(12V/500mA)  
QPS-01



Belt Clip  
BC01

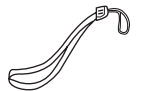

Hand Strap  
GS01

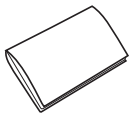

Instruction  
Manual

**\*1.Note: For frequency band of antenna, please refer to label indicated in the bottom of the antenna.**

### Additional Accessories



USB Programming  
Cable PC03

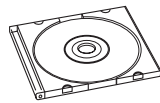

Programming Software  
QPS3318UV\_USA



Earphone  
HS03

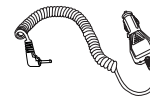

Car Charger  
CPL03

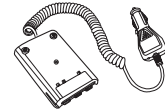

Battery Pack for Car  
Charger CPS01

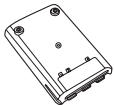

Spare Li-ion Battery  
QB-26HL(2200mAh)

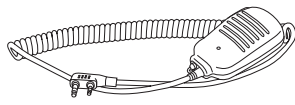

Handheld Microphone  
QHM22

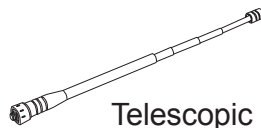

Telescopic antenna  
QA10UV

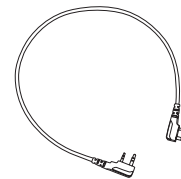

Cloning Cable  
CP04

## OPERATION MODE (AMATEUR TRANSCEIVER OR PROFESSIONAL TRANSCEIVER)

**AnyTone**  
We only do best radio!

The transceiver is a high performance amateur transceiver with dual band, dual standby, dual display and other kinds of functions. According to practical application, you can set the radio to operate as Amateur Transceiver or Professional Transceiver. There are also 3 levels operation menu to set functions as per you need. It is easy and convenient.

### 1. Operation Mode:

A. **By programming software:** In PC software's "General Setting" menu to choose "Display Mode", channel mode works as Professional transceiver, other two modes as Amateur transceiver.

B. **By manual setup:** Please refer to "Display Mode" in Page 47.

2. **Amateur Transceiver Mode:** Except setting as CH mode, others considered as Amateur transceiver mode. Under this mode, press  $\left(\frac{C}{V/M}\right)$  key to switch between Channel mode and VFO.

A. **Frequency + Channel mode:** At this mode, When set display as "FREQ", it enters into Frequency+Channel mode, new setting of channel operation and shortcut operation can be temporarily used by user. Once the radio is turned off or switched to another channel, the temporary setting will be erased and back to initial settings. (As pic 1)

B. **Channel+Name Tag Mode:** When set display as "NAME", it enters into Channel+Name Tag Mode. At this mode, it will display corresponding channel name when the current channel is edited with name. Otherwise, it will display frequency + channel. Its operations are the same as frequency + channel mode. (As pic 2)

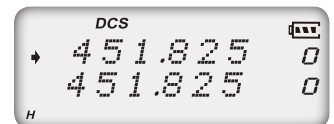

(Pic 1)



(Pic 2)



(Pic 3)



(Pic 4)

## ◦ WORKING MODE (AMATEUR TRANSCEIVER OR PROFESSIONAL TRANSCEIVER)

C. **VFO Mode(Frequency mode)**: This mode shows only frequency on the display. Shortcut operation and Channel setting will be changed & stored as the latest value permanently. Once the radio is turned off or changed to new VFO frequency, the value is remained until next change.(As pic 3)

3. **Professional Transceiver Mode**: When set display mode as "CH", it enters into Professional Transceiver mode. At this mode, except scan, DTMF encode or editing, and keypad lock, other functions should be set by PC software (As pic 4).

**NOTE:If transceiver programmed transceiver as professional mode and locked, you can't return to amateur transceiver mode by manually from Background operations setting.**

4. Under every mode, background operations can be changed and saved.

## ○ BATTERY INFORMATION

**AnyTone**  
*We only do best radio!*

### ((( Charging Operation

The battery is not charged at the factory, please charge it before use. Charge the battery for the first time after purchase or extended storage (more than 2 months) may not bring the battery to its normal operating capacity. After repeating fully charge/ discharge cycle for two or three times, the operating capacity will reach the best performance. The battery life is over when its operating time decreases even though it is fully and correctly charged. Replace the battery.

### ((( Battery Charger Type

Please use our company's designated charger, other models may cause explosion and injure people. After installing the battery, if the radio red light twinkles and remind changing battery, please charge the battery.

### ((( Notice for Charging Battery

- ▲ Do not shortcircuit our company designated charger. Never attempt to remove the casing from the battery, we show no responsibility on the faulty caused by modifying freely without permission of our factory.
- ▲ The ambient temperature should be between 5°C and 40°C in charging. Charging outside this range may not fully charge the battery.
- ▲ Always switch off the transceiver equipped with a battery before charging. Otherwise, it will interfere with correct charging.
- ▲ To avoid interfering the charging procedure, please do not cut off the power or take out the battery during charging.

## ○ BATTERY INFORMATION

- ▲ Do not recharge the battery if it is already fully charged. This may shorten the life of the battery or damage the battery.
- ▲ Do not charge the battery or transceiver if it is damp. Dry it before charging to avoid danger.

### **WARNING:**

**When keys or ornamental chains and other electric metals contact with the battery terminals, the battery may cause damage or hurt bodies. If the battery terminal short circuit, it will generate a lot of heat, please be careful when you bring or use the battery, please put battery or radio into insulated container. Do not put it into metal container.**

## (((How to Charge

1. Plug the AC adaptor into the AC outlet, then plug the cable of AC adaptor into the DC jack, the indicator lights orange for 1s and turns into GREEN---waits to charge.
2. Slide the battery or transceiver with battery into the charger; make sure the battery terminals are in contact with the charging terminals well. LED turns into twinkling RED---pre-charging begins.
3. Pre-charging for about 5 minutes, LED twinkles stop then charging begins.
4. It takes about 4 hours to fully charge the battery, when LED turns into GREEN— full charged.

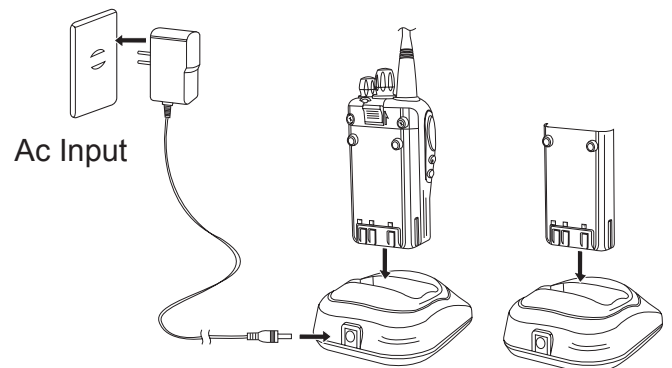





## ○ BATTERY INFORMATION



**NOTE:** When charging a power-on transceiver equipped with battery, the LED will not turn into green to show the full charge status. Only when turn off the transceiver, the LED can indicate normally. Because when the transceiver is power on, it would consumes energy, the charger cannot detect when battery has been fully charged, the charger will charge battery in voltage consumption and fail to indicate correctly.

### 5. Charging Process:

Status	LED
Standby (self-examine orange lights 1second when power on)	 Green light
Pre-charging (pre-charging stage)	 Red light twinkles for about 5 minutes
Charging (charge in constant current)	 RED light lightens for about 4 hours
Full charged (charge in constant voltage)	 Green light

### 6. LED Indicator:

STATUS	self-examine when power on	(No battery)	Pre-charging	Charge normally	Full Charged	Trouble
LED	Orange (for 1 second)	Green	Red light twinkles for 5 minutes	Red	Green	Red twinkles for a long time

**NOTE:** Trouble means battery heating, battery short-circuit or charger short-circuit.



## ○ BATTERY INFORMATION

### ((( Charging Prompt

1. Self- examination: When charging, ORANGE light twinkles for 1 second and goes out. That means the charger has passed its self-examination and it can charge the battery normally. If the light remains orange or the red light twinkles, which means the charger can not pass its self-examination or charge the battery.
2. Trickle pre-charging: When the battery has been inserted into the charger and red light twinkles, which means the remnant voltage is low, the charger trickle charge the battery (pre-charging status ), until the battery reaches a certain electric quantity, the charger automatically turns into normal charging. And if the red light stop twinkling, which means the remnant voltage meets a certain electric quantity, the charger will charge the battery normally.

**NOTE:**The time for Trickle pre-charging should not exceed 30 min. If after 30 min, the red indicator is still twinkling, it means it is unable to charge battery. Please kindly check battery and charger.

### ((( How to Store the Battery

1. If the battery needs to be stored for a long period, the battery should be removed from the radio. It's state of charge should be 50-100% of full charge.
2. It should be kept in low temperature, dry environment.
3. To keep away from hot places and direct sunlight.

#### **WARNING**

- ▲ Do not short circuit battery terminals.
- ▲ Never attempt to remove the casing from the battery pack.
- ▲ Never assemble the battery in dangerous surroundings, spark may cause explosion.
- ▲ Do not put the battery in hot environment or throw it into fire, it may also cause explosion.

## ○ INSTALLATION & CONNECTION

**AnyTone**  
*We only do best radio!*

### 📡 Installing / Removing the Li-ion Battery

1. Match the three grooves of the battery pack with the corresponding guides on the back of the transceiver and push.
2. Press the battery pack and transceiver firmly together until the release latch on the top of the transceiver locks. After hearing a "click" sounds, the battery has been locked.
3. To remove the battery pack, slide up the release latch and remove the pack away from the transceiver.

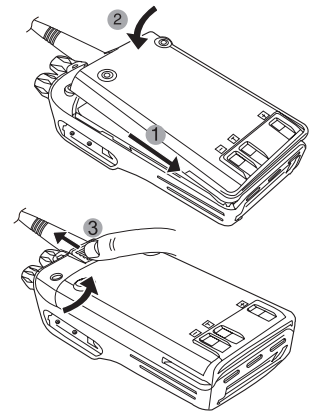

### 📡 Installing / Removing the Antenna

#### ■ Installing the Antenna:

Screw the antenna into the connector on the top of the transceiver by holding the antenna base and turning it clockwise until secure.

#### ■ Removing the Antenna:

Turn the antenna anticlockwise to remove it.

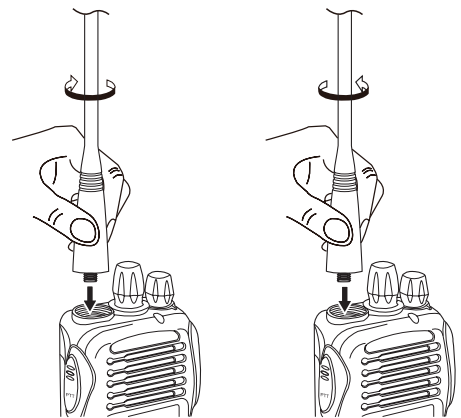

## ○ INSTALLATION & CONNECTION

### ((( Installing / Removing the Belt Clip

#### ■ Installing the Belt Clip:

Place the belt clip to the corresponding grooves on the back of the transceiver, and then Clockwise screw it.

#### ■ Removing the Belt Clip:

Anticlockwise turn screws to remove the belt clip.

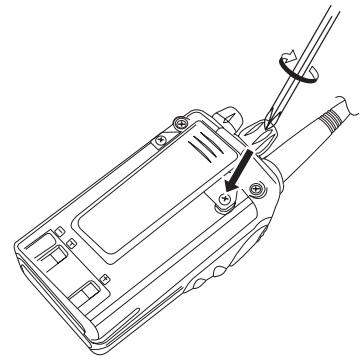

### ((( Installing Optional Speaker / Microphone

Unveil the MIC-SP jack cover and then insert the Speaker/Microphone plug into MIC-SP jack.

**Note:**The transceiver is less water resistant while using the Speaker/Microphone.

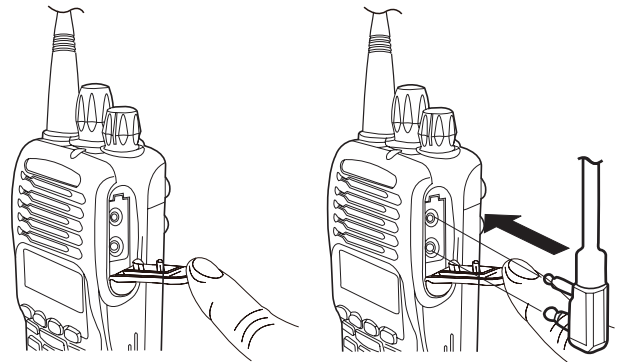

## ◦ INSTALLATION & CONNECTION

**AnyTone**  
*We only do best radio!*

### ((( Installing the Hand Strap

Slide the loop of the hand strap through the eyelet on the upper rear of the transceiver, pull the entire hand strap through the loop to secure the hand strap in place.

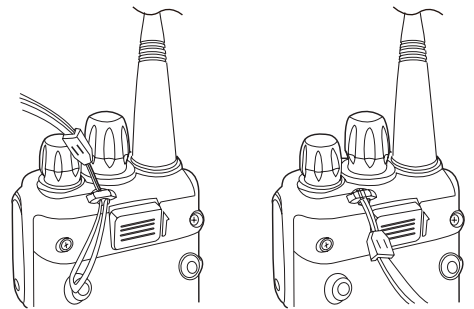



## ◦ GETTING ACQUAINTED

**AnyTone**  
We only do best radio!

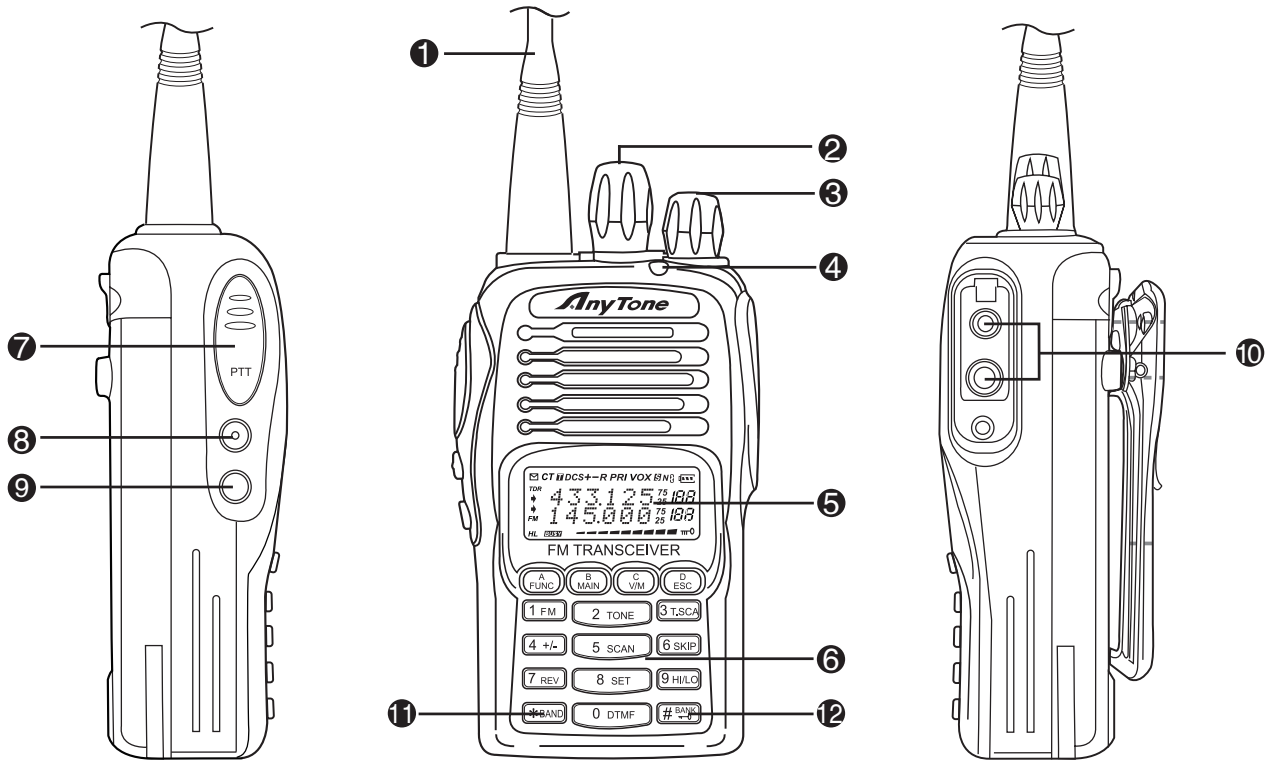

## ◦ GETTING ACQUAINTED

- ❶ Antenna
- ❷ Selector Knob
- ❸ Power/Volume switch  
Rotate it clockwise to turn on transceiver, rotate it anticlockwise until heard "click" to turn off the transceiver.  
When transceiver is power on, rotate it clockwise to increase volume, anticlockwise to reduce volume.
- ❹ TX/RX indicator, RX is GREEN, TX is RED
- ❺ LCD display  
Displays current frequency/channel and operations
- ❻ Keypad  
Enters desired frequency/channel or operations by keypad
- ❼ PTT key  
Press PTT key to talk, release this key to receive.
- ❽ PF1 key
- ❾ PF2 key
- ❿ Speaker/Microphone jack, programming software jack
- ⓫ Single-band Switching
- ⓬ Memory Bank Operation

## ◦ BASIC OPERATIONS

**AnyTone**  
*We only do best radio!*

### ☞ Turn the Radio On & OFF

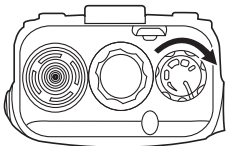

Under power-off state, turn **[POWER]/ [VOLUME]** clockwise to turn on the transceiver.

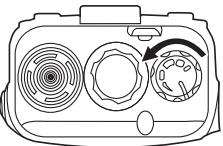

Under power-on state, turn **[POWER]/ [VOLUME]** anticlockwise to turn off the transceiver.

### ☞ Adjusting Volume

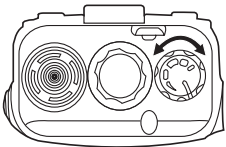

Under power-on state, turn **[POWER] / [VOLUME]** to adjust volume. Clockwise-up, anticlockwise -down.  
When adjusting the volume, user can press the key programmed as Squelch Off to monitor volume level.

#### **NOTE:**

**Press the side key programmed as Squelch Off to monitor the background noise. Turn [POWER] / [VOLUME] to adjust the volume. Turn [Selector Knob] to adjust squelch level for current channel.**



## ○ BASIC OPERATIONS

### (((Switch between Main band and Sub band

Under standby state, press  key to switch between Main band and Sub band. Arrow indicates the Main band.

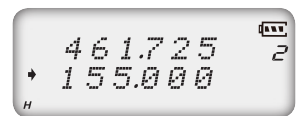

### (((Switch between Channel mode and VFO mode

Under standby state, press  key to set main band as Channel mode or frequency mode(VFO).



### (((Channel Adjusting

With transceiver in Channel mode or FM radio channel mode, rotate channel switch to adjust channel. Rotate channel switch clockwise to increase channel number, anticlockwise to decrease channel number.

**NOTE: In transceiver mode, arrow directs the main band channel.**

**Rotating channel switch will step through only programmed (saved) channels. Unsaved channels will be skipped.**

### (((Frequency Adjusting

With transceiver in VFO mode or FM radio frequency mode, rotate channel switch to adjust frequency. Rotate channel switch clockwise to increase frequency, anticlockwise to decrease frequency. Frequency change depends on chosen frequency step.

## ○ BASIC OPERATIONS

**AnyTone**  
We only do best radio!

**NOTE:** Channel step: 2.5K, 5K, 6.25K, 10K, 12.5K, 20K, 25K, 30K and 50KHz in total 9 for optional. FM radio step frequency is 50K.

### ((( Frequency Input by Keypad

Under frequency mode or FM radio frequency mode, you can directly enter frequency through keypad.

1. When your transceiver is under Channel mode, press  $\left(\frac{C}{V/M}\right)$  key to switch into VFO.

**NOTE:** When the transceiver is under Channel mode, it shows current channel number on the right of main frequency.



2. Enter the desired frequency by keypad.

**NOTE:** The frequency input of main channel or FM radio is relevant to the stepping and transceiver frequency range. If frequency setup is beyond range or not matching with step size, the input is unavailable. Under the FM radio mode, the frequency step size input by numeric keys is 100k.

### ((( Channel Input by Keypad

Under channel mode of transceiver or FM radio, you can switch to desired channel by entering three numbers (001-199). If the entered channel is not a saved channel, the transceiver will emit beep to prompt wrong input and return to current channel. For example, entering 001 is channel 1, 030 is channel 30, 125 is channel 125.



## ○ BASIC OPERATIONS

### ((( Squelch Off Momentary / Squelch Off

Side key [PF2] can be setup for Squelch off Momentary or Squelch off function by programming software.

1. Squelch off: Press [PF2] key, squelch circuit is not mute, back-ground noise can be heard. Press [PF2] key again, squelch circuit is mute.
2. Squelch off Momentary: Press and hold [PF2] key, squelch circuit is not mute, back-ground noise can be heard. Release [PF2] key, squelch circuit is mute.

**NOTE: The above functions are only available after [PF2] key setup in programming software.**

### ((( Receiving

When your transceiver is called by other party, green or blue LED light will be on, LCD backlight will be on at the same time, and the arrow icon will flash, you can hear the calling.

**NOTE: You may not receive the calling when your transceiver is set at high squelch level. If current channel is programmed with decode signal, only the same signaling call can be heard.**

### ((( Transmitting

According to [PF2] key setup in programming software, hold [PF2] key to monitor the channel to ensure it is not busy, press PTT key and talk to speaker.

Please keep the distance between mouth and speaker to be 2.5-5CM, speak in normal tone to get the best acoustic fidelity.

## ○ BASIC OPERATIONS



**NOTE:** When press and hold PTT key, transceiver is transmitting if the red LED light is on, release PTT key to receive calls.

### ((( Emergency Alarm

Under standby state, press and hold [PF1] key which is programmed with ALARM function until LCD displays "**ALARM**", Emergency alarm function is started. This transceiver has 4 Alarm modes for optional, can be setup in programming software. Power off transceiver to exit Alarm.

### ((( Side Key [PF1] function instruction

[PF1] key can be setup in Function Menu 45 for below functions:

1. **VOLT:** Battery capacity inquiry: Under standby, press [PF1] key, LCD displays current battery capacity, press this key again to exit.
2. **CALL:** Transmit the prestored DTMF/5TONE Encode signal in channel.
3. **ALARM:** Long pressing [PF1] key, LCD display "ALARM", transceiver will enable the preset alarm function.
4. **SUBPTT:** Press [PF1] key, transceiver will transmit on sub-band frequency.
5. **Transmit tone pulse frequency:** Press and hold PTT key, then press [PF1] key to transmit selected tone pulse frequency.

**NOTE:** The tone pulse frequency can be set to 1750Hz, 1450Hz, 1000Hz or 2100Hz in programming software. Please refer to function menu No.30 Tone plus frequency setup (Page 44).

## ◦ BASIC OPERATIONS

### ((( Side key [PF2] function instruction

1. Squelch off: Press [PF2] key, squelch circuit is not mute, back-ground noise can be heard. Press [PF2] key again, squelch circuit is mute.
2. Squelch off Momentary: Press and hold [PF2] key, squelch circuit is not mute, back-ground noise can be heard. Release [PF2] key, squelch circuit is mute.
3. Transmit DTMF/5TONE/2TONE signaling: Press and hold [PTT] key, then press [PF2] key to transmit selected DTMF/5TONE/2TONE signaling.
4. Press and hold [PF2] key to turn on transceiver, until transceiver emits "DU" beep, transceiver enter into general functions setup.

### ((( Edit channel

1. Under frequency mode (VFO), enter desired frequency and settings, press  $\left(\begin{smallmatrix} A \\ FUNC \end{smallmatrix}\right)$  key, the top left corner of LCD displays "✉" icon, press  $\left(\begin{smallmatrix} C \\ V/M \end{smallmatrix}\right)$  key to switch into channel mode, channel number flashes.
2. Rotate channel switch to select desired editing channel number.
3. Press  $\left(\begin{smallmatrix} A \\ FUNC \end{smallmatrix}\right)$  key, the top left corner of LCD displays "✉" icon, press and hold  $\left(\begin{smallmatrix} C \\ V/M \end{smallmatrix}\right)$  key until transceiver emits "DUDU" beep, channel is stored successfully.

### ((( Delete channel

1. Under standby state, press  $\left(\begin{smallmatrix} A \\ FUNC \end{smallmatrix}\right)$  key, the top left corner of LCD displays "✉" icon, press  $\left(\begin{smallmatrix} C \\ V/M \end{smallmatrix}\right)$  key to switch into channel mode, channel number flashes.
2. Rotate channel switch to select desired deleting channel number.

## ○ BASIC OPERATIONS

**AnyTone**  
*We only do best radio!*

3. Press **(A)** FUNC key, the top left corner of LCD displays "✉" icon, press and hold **(B)** MAIN key until transceiver emits "DUDU" beep and clear up frequency information of current channel, deletion is successful.

**NOTE: This process can be applied for deleting FM radio channels.**

### 📶 Programming scan

Setup the frequency of L1 channel, U1 channel, L2 channel and U2 channel will realize VFO frequency scanning border limited. L1 & L2 is starting frequency, U1 & U2 is end frequency. When VFO frequency between L1~ U1 or L2 ~ U2, transceiver will scan frequencies between L1 ~ U1 or L2 ~ U2. When VFO frequency is lower than L1 or L2, transceiver will scan frequencies higher than L1 or L2. When VFO frequency is lower than U1 or U2, transceiver will scan frequencies higher than U1 or U2.

1. In VFO mode, enter desired frequency and relative setup, press **(A)** FUNC key, the top left corner of LCD displays "✉" icon, then press **(C)** V/M key switch into channel mode, channel number flashes
2. Rotate channel switch to choose desired channel number.
3. Press **(A)** FUNC key, the top left corner of LCD displays "✉" icon, then press **(C)** V/M key until transceiver emits "DUDU" beep, channels are saved successfully.

**NOTE: To make this setup, L1 and U1 must in same frequency band. L2 and U2 must in same frequency band.**

## ○ SHORTCUT OPERATIONS

### ((( Add/Cancel Optional signal decode function

Under standby state, press **(A) FUNC** key, the top left corner of LCD displays "✉" icon, press **(2) TONE** key.

1. LCD display "DTMF" and "T" icon, DTMF signal add in current channel.
2. Repeat above operation, LCD display "5TONE" and "T" icon, 5TONE signal add in current channel.
3. Repeat above operation, LCD display "2TONE" and "T" icon, 2TONE signal add in current channel.
4. Repeat above operation, LCD display "OFF", the "T" icon disappear, no optional signal in current channel.



**NOTE: When this function is on, user must setup 07th menu to be TONE option, then DTMF/5TONE/2TONE can be used.**

### ((( CTCSS/DCS Scan

Press **(A) FUNC** key, the top left corner of LCD displays "✉" icon, press **(3) T.SCA** key to enter into CTCSS/DCS scan. Under this state, rotate channel switch to change scan direction. When scan the matching CTCSS/DCS signaling, it will stay 5seconds and then go on scanning. Press any other keys except **(A) FUNC**, **(\*BAND)**, **(#BANK) ←** key to exit.



**NOTE: This function is invalid when transceiver works in professional mode or the arrow directed channel no setting CTCSS/DCS signaling.**

**In current channel, if signaling set as CTCSS, it will scan CTCSS, if sets as DCS, will scan DCS.**

## ◦ SHORTCUT OPERATIONS

**AnyTone**  
We only do best radio!

### ((( Offset Frequency Direction Setup

Under standby state, press  $\text{A}_{FUNC}$  key, the top left corner of LCD displays "  $\text{M}$  " icon, press  $\text{4}_{+/-}$  key to choose offset frequency direction. There are 3 options, Positive offset, Minus offset, shut off offset.

1. **(+) Positive offset:** Indicates TX frequency is higher than RX frequency. When enable reverse function, the RX frequency is higher than TX frequency.
2. **(-) Minus offset:** Indicates TX frequency is lower than RX frequency. When enable reverse function, the RX frequency is lower than TX frequency.
3. **None:** Indicates shut offset off.

Under frequency mode (VFO) or channel mode, press  $\text{A}_{FUNC}$  key then press  $\text{4}_{+/-}$  key to choose positive offset direction(+), minus offset direction (-) , shut offset off one by one (Please refer to offset frequency setup).

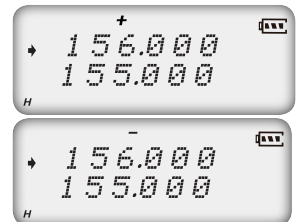

**NOTE: This function is unavailable in professional transceiver mode.**

### ((( Frequency/Channel Scan

Under corresponding mode, press  $\text{A}_{FUNC}$  key, the top left corner of LCD displays "  $\text{M}$  " icon, then press  $\text{5}_{SCAN}$  key to start frequency scan or channel scan.

#### 1. Frequency Scan

Under VFO mode, frequency scan is available. This function is used for monitoring signal of various communication frequency by transceiver 'step' setup, press numeric key or  $\text{D}_{ESC}$  key to exit.

#### 2. Channel Scan

Under channel mode, this function is used for monitoring signal of each channel

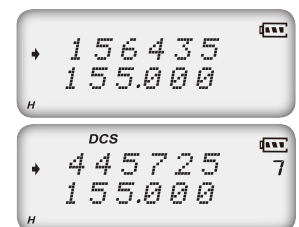



## ◦ SHORTCUT OPERATIONS

in this mode. Press numeric key or  $\left(\frac{D}{ESC}\right)$  key to exit.

### NOTE:

- ▼ Frequency scan is of all bands scan, it scans upwards as your STEPPING setting.
- ▼ In channel scan, the skipped channel is not in the line of scanning. Scan upwards as per channel no. (please refer to channel scan skip).
- ▼ Frequency/channel scan can change scan direction by rotating channel switch, when find a matching carrier wave and signaling, the transceiver will stay 5 seconds then go on scanning. (Please refer to scan setup)

If turn off radio in scan mode, when re-power on, radio will resume scanning automatically.

### ((( Channel Scan Skip

Under channel mode, press  $\left(\frac{A}{FUNC}\right)$  key, the top left corner of LCD displays "✉" icon, then press  $\left(\frac{6}{SKIP}\right)$  key to set current arrow directed channel as Channel scan skip. Repeat above operation to cancel channel scan skip.

1. LCD displayed "S" means the current channel will not be scanned.
2. "S" icon disappeared means the current channel will be scanned.



### ((( Frequency Reverse

Under standby state, press  $\left(\frac{A}{FUNC}\right)$  key, the top left corner of LCD displays "✉" icon, then press  $\left(\frac{7}{REV}\right)$  key to set arrow directed channel as frequency reverse, repeat above operation to turn off frequency reverse.

1. When LCD displays "R" icon, it means current arrow directed channel open the frequency reverse function, the TX frequency and RX frequency is interchanged,

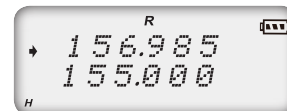

## ◦ SHORTCUT OPERATIONS

**AnyTone**  
We only do best radio!

if CTCSS/DCS signaling is set, it will also interchange.

2. When "R" icon disappears, it means reverse function is close.

### ☞ TX Power selection

Under standby state, press  $\left(\begin{smallmatrix} A \\ FUNC \end{smallmatrix}\right)$  key, the top left corner of LCD displays "☒" icon, then press  $\left(\begin{smallmatrix} 9 \\ HI/LO \end{smallmatrix}\right)$  key to choose High/Low power for current arrow directed channel.

1. When LCD displays "L" icon, it means low power is chose.
2. When LCD displays "H" icon, it means high power is chose.



### ☞ Talk Around function

Under standby state, press  $\left(\begin{smallmatrix} A \\ FUNC \end{smallmatrix}\right)$  key, the top left corner of LCD displays "☒" icon, then press  $\left(\begin{smallmatrix} * \\ BAND \end{smallmatrix}\right)$ , the arrow directed channel will enable talk around, repeat the above operation to close talk around.

1. **TX=RX**: Enable talk around, current channel transmit at RX frequency, if CTCSS/DCS signaling is set, it will interchange decoding CTCSS/DCS as encoding.
2. **OFF**: Close talk around.





### ☞ DTMF code Transmit and Enquiry

1. Press  $\left(\begin{smallmatrix} A \\ FUNC \end{smallmatrix}\right)$  key, the top left corner of LCD displays "☒" icon, then press  $\left(\begin{smallmatrix} 0 \\ DTMF \end{smallmatrix}\right)$  key, LCD displays DTMF data and group number (total 16groups) of current group.
2. Rotate channel switch to choose desired group and DTMF data, press PTT key to transmit selected DTMF signaling. If current group not edit DTMF data, LCD



## ○ SHORTCUT OPERATIONS

displays "EMPTY".

3. When current group displays "EMPTY", press  key, the top left corner of LCD displays "✉" icon, press and hold  key until transceiver emits "DU" beep, transceiver enters into DTMF edit state, LCD displays "\_\_\_\_\_"; now you can enter desired DTMF data by keypad.

4. When finished editing, press side key [PF2] to save DTMF signaling.

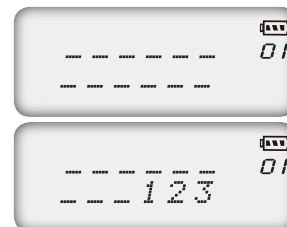



### ((( Keypad lock

In order to prevent wrong operation, user can make use of keypad lock function.

When keypad lock is turned on, only channel selector is available for changing channels, all other keys are locked. Keypad lock operation can be done through software programming and radio itself.

- 1) Radio itself operation

Under standby state, press  key, the top left corner of LCD displays "✉" icon, then press and hold  key until transceiver emits "DU" beep, LCD displays "🔒" icon, keypad is locked. Repeat above operation, "🔒" icon disappears, key lock function is cancelled.



- 2) Software Programming

**ON:** Keypad lock option tick on.

**OFF:** Keypad lock option tick off.

**Note:** When keypad lock is turned on by software programming, the radio itself keypad lock operation is invalid.

## ◦ SHORTCUT OPERATIONS

**AnyTone**  
*We only do best radio!*

### Single-band Switching

To reduce the interference from the sub-channel when the main channel be used. You can use single-band switching function, turn off the sub-channel bands quickly.

1. In standby mode, press the **\*BAND** button, the radio will display the PC channel, and turn off the processor channel.
2. Click the **\*BAND** button again, the radio will display the processor channel, and turn off the PC channel.
3. Press the **\*BAND** button again to return to dual-band show.

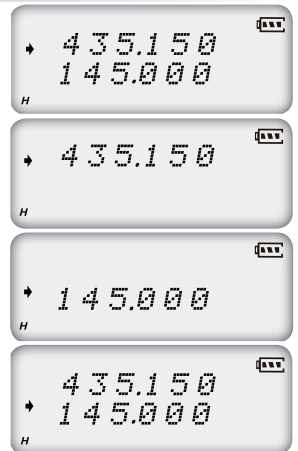

### CTCSS/DCS encode and decode

1. Press **A** FUNC key then press [PF2] to enter into setup.
2. Press [PF2] key to choose CTCSS, DCS or OFF, when choose DCS, press **\*BAND** key to select positive or negative code.
3. Rotate Channel selector to choose desired CTCSS/DCS encode and decode.
4. Press **D** ESC key or **#** BANK ← → key to confirm and exit.

## ○ FUNCTION MENU SETUP

Menu 1-14 of this transceiver are channel operations. Channel operations temporarily changed the functions of current channel. When power off or channel has been changed, the relevant setup will be erased. Only under VFO mode, the channel operations will be saved until next change. Menu 15-45 is background operation(menu 33-44 is memory bank setup, please refer to page 50-51), it is valid for all channels, the relevant setup will be saved until next change.

The operating methods are as follows:

1. Press **(A)<sub>FUNC</sub>** key, the top left corner of LCD displays "✉" icon, then press **(8)<sub>SET</sub>** key to enter function menu.
2. Press **(B)<sub>MAIN</sub>** / **(C)<sub>V/M</sub>** key to choose desired function.
3. Rotate channel switch to choose desired setting.
4. Press **(D)<sub>ESC</sub>** key or **(#)<sub>BANK</sub>** key to confirm and exit.

### ((( CTCSS/DCS Encode Setup

1. Press **(A)<sub>FUNC</sub>** key, the top left corner of LCD displays "✉" icon, then press **(8)<sub>SET</sub>** key to enter into function menu.
2. Press **(B)<sub>MAIN</sub>** / **(C)<sub>V/M</sub>** key to choose NO.01 function item, it shows "T-CDC" on LCD.
3. Press **(1)<sub>FM</sub>** key to choose CTCSS, DCS or OFF, when DCS signaling is selected, press **(\*<sub>BAND</sub>)** key to choose DCS positive or inverse code.
4. Rotate channel switch to choose desired CTCSS/DCS code.  
**CTCSS:** 62.5HZ-254.1HZ, 51groups in total, and 1 group user-defined code.  
**DCS:** 000N-777I, 1024 groups in total. "N" stands for positive code, "I" stands for inverse code.
5. Press **(D)<sub>ESC</sub>** or **(#)<sub>BANK</sub>** key to confirm and exit.

**Note: User-defined CTCSS encode must be setup by programming software.**

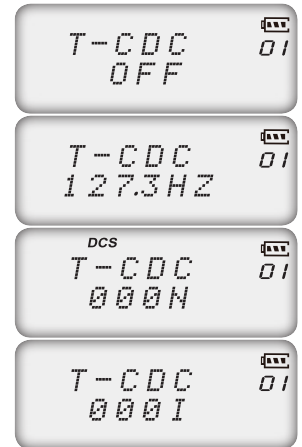

## ○ FUNCTION MENU SETUP

**AnyTone**  
We only do best radio!

### ((( CTCSS/DCS Decode Setup

If this function is enabled, you can ignore (can not hear) other unrelated call at the same frequency.

1. Press **(A)** FUNC key, the top left corner of LCD displays "✉" icon, then press **(8)** SET key to enter into function menu.
2. Press **(B)** MAIN / **(C)** V/M key to choose NO. 02 function item, it shows "R-CDC" on LCD.
3. Press **(1)** FM key to choose CTCSS,DCS or OFF, when DCS signaling is selected, press **(\*)** BAND key to choose DCS positive or inverse code.
4. Rotate channel switch to choose desired CTCSS/DCS code.  
**CTCSS:** 62.5HZ~254.1HZ, 51 groups in total, and 1 group user-defined code.  
**DCS:** 000N-777I, 1024 groups in total. "N" stands for positive code, "I" stands for inverse code.
5. Press **(D)** ESC or **(#)** BANK LO key to confirm and exit.

**Note:** User-defined CTCSS decode must be setup by programming software.

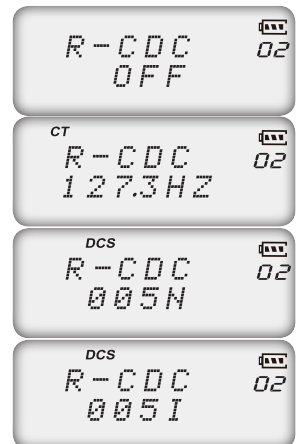

### ((( CTCSS/DCS Encode/Decode Synchronous Setup

This function is for adjusting CTCSS/DCS encode/decode synchronous.

1. Press **(A)** FUNC key, the top left corner of LCD displays "✉" icon, then press **(8)** SET key to enter into function menu.
2. Press **(B)** MAIN / **(C)** V/M key to choose NO. 03 function item, it shows "RT-CDC" on LCD.



## ○ FUNCTION MENU SETUP

3. Press **1 FM** key to choose CTCSS, DCS or OFF, when DCS signaling is selected, press **\*BAND** key to choose DCS positive or inverse code.
4. Rotate channel switch to choose desired CTCSS/DCS encode/decode.  
**CTCSS:** 62.5HZ~254.1HZ, 51 groups in total, and 1 group user-defined code.  
**DCS:** 000N-777I, 1024 groups in total. "N" stands for positive code, "I" stands for inverse code.
5. Press **D ESC** or **# BANK** key to confirm and exit.

**Note:** User-defined CTCSS decode must be setup by programming software.



CT  
RT-CDC 03  
127.3HZ



DCS  
RT-CDC 03  
005N



DCS  
RT-CDC 03  
005I

## ((( 5TONE encode group selection

1. Press **A FUNC** key, the top left corner of LCD displays "☑" icon, then press **B SET** key to enter into function menu.
2. Press **B MAIN** / **C V/M** key to choose NO.04 function item, it shows "5T-ENC" on LCD.
3. Rotate channel switch to choose desired 5TONE encode group.  
CALL00~CALL99, 100 groups in total for optional.
4. Press [PTT] key to transmit selected 5TONE encode, press **D ESC** key or **# BANK** key to confirm and exit.



5T-ENC 04  
CALL00

**5TONE encode must be programmed by software, only the groups with editing 5TONE can be selected. When 5TONE encode is editing with name, transceiver will display name, otherwise will display "CALL XX".**

## ○ FUNCTION MENU SETUP

**AnyTone**  
We only do best radio!

### ☞ 2TONE encode group selection

1. Press **(A)** FUNC key, the top left corner of LCD displays "✉" icon, then press **(8)** SET key to enter into function menu.
2. Press **(B)** MAIN / **(C)** V/M key to choose NO.05 function item, it shows "2T-ENC" on LCD.
3. Rotate channel switch to choose desired 2TONE encode group.  
CALL00~CALL31, 32 groups in total for optional.
4. Press [PTT] key to transmit selected 2TONE encode, press **(D)** ESC key or **(#)** BANK 1-20 key to confirm and exit.



2T-ENC 05  
CALL00

**2TONE encode must be programmed by software, only the groups with editing 2TONE can be selected. When 2TONE encode is editing with name, transceiver will display name, otherwise will display "CALL XX".**

### ☞ Optional signaling setup

DTMF and 5TONE functions are similar to CTCSS/DCS, it has special call functions, such as ANI, PTT ID, All call, Alarm, remotely kill, remotely stun and remotely waken, etc..

1. Press **(A)** FUNC key, the top left corner of LCD displays "✉" icon, then press **(8)** SET key to enter into function menu.
2. Press **(B)** MAIN / **(C)** V/M key to choose NO.06 function item, it shows "TONDEC" on LCD.
3. Rotate channel switch to choose desired optional signaling.

**DTMF:** Current optional signaling is DTMF.

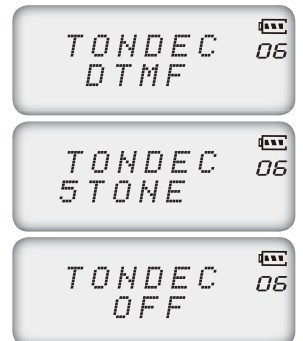

TONDEC 06  
DTMF

TONDEC 06  
5TONE

TONDEC 06  
OFF



## ○ FUNCTION MENU SETUP

**5TONE/2TONE:** Current optional signaling is 5TONE/2TONE.

**OFF:** Close optional signaling.

4. Press **(D ESC)** key or **(# BANK ←)** key to confirm and exit.

### ((( Squelch mode setup

This function is used for setting squelch mode to prevent receiving unrelated signals.

1. Press **(A FUNC)** key, the top left corner of LCD displays "✉" icon, then press **(8 SET)** key enter into function menu.
2. Press **(B MAIN) / (C V/M)** key to choose NO.07 function item, it shows "**SIGNAL**" on LCD.
3. Rotate channel switch to choose desired squelch mode.

**SQ:** When current channel receives matching RF signals, transceiver can hear the talking from the other party.

**CT/DCS:** When current channel receives matching RF signals and matching CTCSS/DCS signaling, transceiver can hear the talking from the other party.

**TONE:** When current channel receives matching RF signals and matching optional signaling, transceiver can hear the talking from the other party.

**CT&TO:** When current channel receives matching RF signals+matching optional signaling + matching CTCSS/DCS signaling, transceiver can hear the talking from the other party.

**CT/TO:** When current channel receives matching RF signals, or matching optional signaling, or matching CTCSS/DCS signaling, transceiver can hear the talking from the other party.



## ○ FUNCTION MENU SETUP

**AnyTone**  
We only do best radio!

4. Press **(D)** ESC key or **(#)** BANK key to confirm and exit.

### ((( Frequency step size setup

1. Press **(A)** FUNC key, the top left corner of LCD displays "✉" icon, then press **(8)** SET key enter into function menu.
2. Press **(B)** MAIN / **(C)** V/M key to choose NO. 08 function item, it shows "STEP" on LCD.
3. Rotate channel switch to choose desired step size.  
**Stepping:** 2.5K, 5K, 6.25K, 10K, 12.5K, 20K, 25K, 30K, 50K, 9 options in total.
4. Press **(D)** ESC key or **(#)** BANK key to confirm and exit.



STEP 5K NO. 08



STEP 6.25K NO. 08

**NOTE:** This function item will hide automatically when main band and sub main band are under channel mode.

### ((( Wide / Narrow Band Selection

According to the national conditions of various countries, it can be set for communication by wide band or narrow band.

1. Press **(A)** FUNC key, the top left corner of LCD displays "✉" icon, then press **(8)** SET key enter into function menu.
2. Press **(B)** MAIN / **(C)** V/M key to choose NO. 09 function item, it shows "W/N" on LCD.
3. Rotate channel switch to choose desired setup.  
**25K:** Wide band; **12.5K:** Narrow band.
4. Press **(D)** ESC key or **(#)** BANK key to confirm and exit.



W/N 25K NO. 09



W/N<sup>N</sup> 12.5K NO. 09

## ○ FUNCTION MENU SETUP

### ((( Frequency Reverse

1. Press **(A)** FUNC key, the top left corner of LCD displays "☒" icon, then press **(B)** SET key enter into function menu.

2. Press **(B)** MAIN / **(C)** V/M key to choose NO.10 function item, it shows "REV" on LCD.

3. Rotate channel switch to choose desired setup.

**ON:** Turn on Frequency reverse function, TX and RX frequency of current channel will be interchanged. If CTCSS/DCS signaling is set, it also will be interchanged.

**OFF:** Close Frequency reverse function.

4. Press **(D)** ESC key or **(#)** BANK 10 key to confirm and exit.



### ((( Talk Around ON/OFF

When this function is on, transceiver will cut communication with repeater.

1. Press **(A)** FUNC key, the top left corner of LCD displays "☒" icon, then press **(B)** SET key enter into function menu.

2. Press **(B)** MAIN / **(C)** V/M key to choose NO.11 function item, it shows "TALKAR" on LCD.

3. Rotate channel switch to choose desired setup.

**TX=RX:** Turn on Talk Around function, current channel will transmit at RX frequency, if CTCSS/DCS signaling is set, it will interchange decoding CTCSS/DCS as encoding.

**OFF:** Close Talk Around function.

4. Press **(D)** ESC key or **(#)** BANK 10 key to confirm and exit.



## ○ FUNCTION MENU SETUP

**AnyTone**  
We only do best radio!

### ((( Offset Frequency setup

This function works through repeater. When repeater receives signals at one frequency, it transmits at the other frequency. The offset between these two frequencies is called offset frequency.

1. Press **(A)** FUNC key, the top left corner of LCD displays "✉" icon, then press **(B)** SET key enter into function menu.
2. Press **(B)** MAIN / **(C)** V/M key to choose NO.12 function item, it shows "OFFSET" on LCD.
3. Rotate channel switch to choose desired offset frequency.  
Frequency range is 00-70MHZ.
4. Press **(D)** ESC key or **(#)** BANK ↕ ↕ key to confirm and exit.

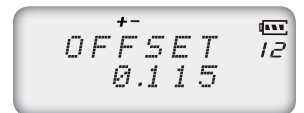

### ((( Editing Channel name

1. Press **(A)** FUNC key, the top left corner of LCD displays "✉" icon, then press **(B)** SET key enter into function menu.
2. Press **(B)** MAIN / **(C)** V/M key to choose NO.13 function item, it shows "-" on LCD.
3. Rotate channel switch to choose desired character, press **(1)** FM key to confirm current character and move shift to next character. Press **(4)** +/- key back to the previous character.
4. Press **(D)** ESC key or **(#)** BANK ↕ ↕ key to confirm and exit.



### ((( Busy Channel Lockout

BCLO function is used for prohibit transmitting on busy channel, it can prevent disturbing other transceivers

## ○ FUNCTION MENU SETUP

operating in same frequency. If you press PTT, the radio will beep as warning and get back to receiving state.

1. Press **(A)** FUNC key, the top left corner of LCD displays "✉" icon, then press **(8)** SET key enter into function menu.
2. Press **(B)** MAIN / **(C)** V/M key to choose NO.14 function item, it shows "RPLOCK" on LCD.
3. Rotate channel switch to choose desired setup.  
**BUSY:** Carrier wave lock, transmitting is prohibited when received matching carrier wave.  
**REPEAT:** Signaling lock, transmitting is prohibited when received matching carrier but with unmatching CTCSS/DCS.  
**OFF:** Close BCLO function.
4. Press **(D)** ESC key or **(#)** BANK → **(0)** key to confirm and exit.



## (((TX OFF

When this function is on, [PTT] key is unavailable. Current channel of transceiver only works under receiving mode.

1. Press **(A)** FUNC key, the top left corner of LCD displays "✉" icon, then press **(8)** SET key enter into function menu.
2. Press **(B)** MAIN / **(C)** V/M key to choose NO.15 function item, it shows "TX" on LCD.
3. Rotate channel switch to choose desired setup.  
**ON:** TX OFF is enabled.  
**OFF:** TX OFF is disabled.
4. Press **(D)** ESC key or **(#)** BANK → **(0)** key to confirm and exit.



## ○ FUNCTION MENU SETUP

**AnyTone**  
We only do best radio!

### Band Limit

When this function is on, inputting frequency or Scanning frequency under VFO is limited in current VFO frequency band.

1. Press **(A)** FUNC key, the top left corner of LCD displays "✉" icon, then press **(8)** SET key enter into function menu.
2. Press **(B)** MAIN / **(C)** V/M key to choose NO.16 function item, it shows "BAND" on LCD.
3. Rotate channel switch to choose desired setup.  
**ON:** Band limit is enabled.  
**OFF:** Band limit is disabled.
4. Press **(D)** ESC key or **(#)** BANK ↕ ↕ ↕ key to confirm and exit.

BAND  
ON 16

BAND  
OFF 16

### Sub Band Display Setup

1. Press **(A)** FUNC key, the top left corner of LCD displays "✉" icon, then press **(8)** SET key enter into function menu.
2. Press **(B)** MAIN / **(C)** V/M key to choose NO.17 function item, it shows "DPSUB" on LCD.
3. Rotate channel switch to choose desired setup.  
**FREQ:** Display sub band frequency or channel.  
**VOLT:** Display current battery voltage.  
**OFF:** Sub band display is disabled.
4. Press **(D)** ESC key or **(#)** BANK ↕ ↕ ↕ key to confirm and exit.

DPSUB  
FREQ 17

DPSUB  
VOLT 17

DPSUB  
OFF 17

## ○ FUNCTION MENU SETUP

### ⌘ Keypad Voice Prompt Setup

1. Press **(A)** FUNC key, the top left corner of LCD displays "✉" icon, then press **(8)** SET key enter into function menu.
2. Press **(B)** MAIN / **(C)** V/M key to choose NO.18 function item, it shows "BEEP" on LCD.
3. Rotate channel switch to choose desired setup.  
**ON:** Keypad Voice Prompt is enabled.  
**OFF:** Keypad Voice Prompt is disabled.
4. Press **(D)** ESC key or **(#)** BANK ↺ ↻ key to confirm and exit.



### ⌘ Time-Out-Timer (TOT)

The purpose of Time-out-Timer is to restrict transceiver for continuous long-term transmission. When the continuous transmission time is beyond the preset time, transceiver is forced to stop transmitting and make a beep sound.

1. Press **(A)** FUNC key, the top left corner of LCD displays "✉" icon, then press **(8)** SET key enter into function menu.
2. Press **(B)** MAIN / **(C)** V/M key to choose NO.19 function item, it shows "TOT" on LCD.
3. Rotate channel switch to choose desired setup.  
1~27 minutes, total 27minutes of TOT for optional, each interval is 1minute.
4. Press **(D)** ESC key or **(#)** BANK ↺ ↻ key to confirm and exit.



## ○ FUNCTION MENU SETUP

**AnyTone**  
We only do best radio!

### ((( Voice Operated Transmission (VOX) Setup

When this function is on, the transmitting can be started by voice, no need to press [PTT] key.

1. Press **(A)** FUNC key, the top left corner of LCD displays "✉" icon, then press **(8)** SET key enter into function menu.
2. Press **(B)** MAIN / **(C)** V/M key to choose NO. 20 function item, it shows "VOX" on LCD.
3. Rotate channel switch to choose desired setup.  
**1~10**: Total 10 VOX levels for optional.  
**OFF**: VOX function is disabled.
4. Press **(D)** ESC key or **(#)** BANK ↓ ↑ key to confirm and exit.



### ((( VOX Delay Setup

If transceiver returns to receive mode instantly after VOX calling, it may cause calling voice missing. To avoid this problem, user can set a suitable delay time.

1. Press **(A)** FUNC key, the top left corner of LCD displays "✉" icon, then press **(8)** SET key enter into function menu.
2. Press **(B)** MAIN / **(C)** V/M key to choose NO.21 function item, it shows "VDELAY" on LCD.
3. Rotate channel switch to choose desired setup.  
**0.5S-3S**: Total 27 levels for optional, each interval is 0.1S
4. Press **(D)** ESC key or **(#)** BANK ↓ ↑ key to confirm and exit.





## ○ FUNCTION MENU SETUP

### Ⓜ Automatic Power Off Time setup

When this function is on, transceiver will automatic power off when reach the preset time.

1. Press **(A)** FUNC key, the top left corner of LCD displays "✉" icon, then press **(8)** SET key enter into function menu.
2. Press **(B)** MAIN / **(C)** V/M key to choose NO. 22 function item, it shows "APO" on LCD.
3. Rotate channel switch to choose desired setup.  
30minutes ~ 2hours: Total 3 levels for optional.  
**OFF**: Automatic Power Off Time is disabled.
4. Press **(D)** ESC key or **(#)** BANK LO key to confirm and exit.



### Ⓜ DTMF Transmitting Time Setup

1. Press **(A)** FUNC key, the top left corner of LCD displays "✉" icon, then press **(8)** SET key enter into function menu.
2. Press **(B)** MAIN / **(C)** V/M key to choose NO. 23 function item, it shows "DTMF" on LCD.
3. Rotate channel switch to choose desired setup.  
**50MS**: Each DTMF signal transmits 50ms, interval 50ms.  
**100MS**: Each DTMF signal transmits 100ms, interval 100ms.  
**200MS**: Each DTMF signal transmits 200ms, interval 200ms.  
**300MS**: Each DTMF signal transmits 300ms, interval 300ms.  
**500MS**: Each DTMF signal transmits 500ms, interval 500ms.
4. Press **(D)** ESC key or **(#)** BANK LO key to confirm and exit.



## ○ FUNCTION MENU SETUP

**AnyTone**  
We only do best radio!

### ((( Squelch level setup

This function is used for setup intensity of receiving signals, transceiver will hear calls when receiving signal intensity achieve preset data, otherwise, transceiver will keep mute.

1. Press **(A)** FUNC key, the top left corner of LCD displays "✉" icon, then press **(8)** SET key enter into function menu.
2. Press **(B)** MAIN / **(C)** V/M key to choose NO. 24 function item, it shows "SQL" on LCD.
3. Rotate channel switch to choose desired setup.  
**00~09**: 10 levels of squelch in total for optional, "00" is minimum setup value (normally open).
4. Press **(D)** ESC key or **(#)** BANK ↔ ↔ key to confirm and exit.



### ((( Scan Dwell Time Setup

There are three kinds of scan dwell time for optional.

1. Press **(A)** FUNC key, the top left corner of LCD displays "✉" icon, then press **(8)** SET key enter into function menu.
2. Press **(B)** MAIN / **(C)** V/M key to choose NO. 25 function item, it shows "SCAN" on LCD.
3. Rotate channel switch to choose desired setup.  
**5ST**: When scanning matched signal, transceiver will stop scanning for 5seconds then resume.  
**10ST**: When scanning matched signal, transceiver will stop scanning for 10seconds then resume.  
**15ST**: When scanning matched signal, transceiver will stop scanning for 15seconds then resume.  
**2SP**: When scanning matched signal, transceiver will stop scanning, 2seconds after signal disappears, scanning will resume.
4. Press **(D)** ESC key or **(#)** BANK ↔ ↔ key to confirm and exit.



## ○ FUNCTION MENU SETUP

### ((( Function Icon Stay Time Setup

1. Press **(A)** FUNC key, the top left corner of LCD displays "☒" icon, then press **(8)** SET key enter into function menu.
2. Press **(B)** MAIN / **(C)** V/M key to choose NO. 26 function item, it shows "FTIME" on LCD.
3. Rotate channel switch to choose desired setup.

**FUNCT:** When finished function setting or enter into function menu, icon disappeared.

**1SEC:** When finished function setting or enter into function menu, icon stay 1second then disappeared.

**2SEC:** When finished function setting or enter into function menu, icon stay 2seconds then disappeared.

**3SEC:** When finished function setting or enter into function menu, icon stay 3seconds then disappeared.

**ALWAYS:** Function icon is always display, only when pressing function key again, the icon will disappear.



FTIME  
FUNCT 26



FTIME  
1SEC 26



FTIME  
ALWAYS 26

4. Press **(D)** ESC key or **(#)** BANK 1-0 key to confirm and exit.

**NOTE:** When function icon is staying, user can setup desired functions continuously, no need press function key every time.

### ((( LCD Backlight Setup

1. Press **(A)** FUNC key, the top left corner of LCD displays "☒" icon, then press **(8)** SET key enter into function menu.
2. Press **(B)** MAIN / **(C)** V/M key to choose NO. 27 function item, it shows "LIGHT" on LCD.
3. Rotate channel switch to choose desired setup.

**AUTO:** Backlight will automatic closed after a period.



LIGHT  
AUTO 27



LIGHT  
ON 27

## ○ FUNCTION MENU SETUP

**AnyTone**  
We only do best radio!

**OFF:** Always off.

**ON:** Always on.

4. Press **(D ESC)** key or **(# BANK 1-0)** key to confirm and exit.



## ((( LCD Backlight Color Setup

There are three kinds of backlight color for optional.

1. Press **(A FUNC)** key, the top left corner of LCD displays "✉" icon, then press **(8 SET)** key enter into function menu.
2. Press **(B MAIN) / (C V/M)** key to choose NO. 28 function item, it shows "COLOR" on LCD.
3. Rotate channel switch to choose desired setup.
  - BLUE:** Blue backlight.
  - ORG:** Orange backlight.
  - PUR:** Purple backlight.
4. Press **(D ESC)** key or **(# BANK 1-0)** key to confirm and exit.



## ((( Self ID inquiry

1. Press **(A FUNC)** key, the top left corner of LCD displays "✉" icon, then press **(8 SET)** key enter into function menu.
2. Press **(B MAIN) / (C V/M)** key to choose NO. 29 function item, it shows "ID" on LCD.
3. Rotate channel switch to choose desired setup.

The ID code displaying on LCD is transceiver self ID code.

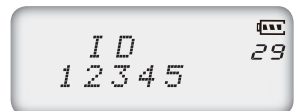

## ○ FUNCTION MENU SETUP

4. Press **(D)** key or **(#)** key to confirm and exit.

**NOTE:** When current channel add 5TONE to be optional signaling, LCD displays 5TONE self ID code, otherwise displays DTMF self ID code.

### ((( Tone Pulse Frequency Selection

This function is used for waking up sleeping repeater, it needs a certain intensity of Tone Pulse to wake up sleeping repeater. In general, as long as the repeater has been waked up, no need to transmit Tone Pulse again in preset time.

1. Press **(A)** key, the top left corner of LCD displays "☑" icon, then press **(B SET)** key enter into function menu.
2. Press **(B)** / **(C)** key to choose NO. 30 function item, it shows "TBST" on LCD.
3. Rotate channel switch to choose desired setup.  
1750HZ, 2100HZ, 1450HZ, 1000HZ, 4 kinds of Tone Pulse for optional.
4. Press **(D)** key or **(#)** key to confirm and exit.



### ((( Battery Save Setup

User can setup battery save ratio according to requirements. The standby time can be extended when enable battery save function, but if save ratio setting too high, it may cause voice missing.

1. Press **(A)** key, the top left corner of LCD displays "☑" icon, then press **(B SET)** key enter into function menu.
2. Press **(B)** / **(C)** key to choose NO. 31 function item, it shows "SAVE" on LCD.
3. Rotate channel switch to choose desired setup.

**OFF:** Battery Save is disabled.



## ○ FUNCTION MENU SETUP

**AnyTone**  
We only do best radio!

- 1:2: The standby time between normal working state and battery saving mode is 1:2
- 1:3: The standby time between normal working state and battery saving mode is 1:3
- 1:5: The standby time between normal working state and battery saving mode is 1:5
- 1:8: The standby time between normal working state and battery saving mode is 1:8
- AUTO:** Battery save ratio is adjusting automatically.



4. Press **[D ESC]** key or **[# BANK 1:0]** key to confirm and exit.

**Remind: When single band UHF or VHF in standby, proposed setup is 1:8, when dual band VV, UU or UV in standby, proposed setup is 1:2.**

## ((( FM radio

FM Radio Mode allows listening to FM Broadcast stations.

1. Press **[A FUNC]** key, the top left corner of LCD displays "✉" icon, then press **[8 SET]** key enter into function menu.
2. Press **[B MAIN] / [C V/M]** key to choose NO. 32 function item, it shows "RADIO" on LCD.
3. Rotate Selector Knob to choose desired setup.

**ON:** FM Radio Mode is enabled.

**OFF:** FM Radio Mode is disabled.

4. Press **[D ESC]** key to dismiss or **[# BANK 1:0]** key to confirm and exit.



**NOTE: Only when this function is ON, can FM Radio be normally used.**

## ((( FM Radio Functions

1. Press **[A FUNC] + [1 FM]** to turn on FM Radio. Press again to turn off. ON/OFF cycle of radio will end FM Radio

## ○ FUNCTION MENU SETUP

- reception. Also when FM Radio is on, quick press of **(B MAIN)** key will mute / un-mute FM Radio.
2. FM Radio activates in either VFO Mode and Channel Mode. In Channel Mode, LCD shows received frequency with saved channel number to right hand side. In VFO Mode, only received frequency will show. Press **(C V/M)** to cycle between these two modes.
  3. Depending on mode, the keypad can be used to directly enter the number of a saved channel or the frequency of a desired FM Broadcast station.
  4. Depending on mode, rotating Selector Knob will step through saved channels or through VFO frequencies.
  5. Press **(A FUNC)** + **(5 SCAN)** to scan VFO frequencies. Press **(D ESC)** to end scan when desired station is found.

### ((( PF1 key Function Setup

1. Press **(A FUNC)**, the top left corner of LCD display "✉" icon, then press **(8 SET)** key to enter into function menu.
2. Press **(B MAIN)** / **(C V/M)** key to choose No.45 function item, it shows "PF1" on LCD.
3. Turn channel switch to choose desired setup.
  - VOLT:** Display current battery voltage.
  - CALL:** Calling.
  - ALARM:** Emergency alarm.
  - SUBPTT:** Sub band PTT.
  - OFF:** Close the key function.
4. Press **(D ESC)** or **(# BANK 1-0)** to confirm and exit.



## SENIOR FUNCTION OPERATIONS

**AnyTone**  
We only do best radio!

### Display Mode Setup

There are three kinds of display modes for optional.

1. Press [PF2] key to turn on radio, hold [PF2] key until transceiver emits beep.
2. Press  $\left(\frac{B}{MAIN}\right) / \left(\frac{C}{V/M}\right)$  key to choose No.01 function item, it shows "DSP" on LCD.
3. Rotate channel switch to choose desired setup.

**FREQ:** Frequency+Channel mode, transceiver displays current channel name + frequency, press  $\left(\frac{C}{V/M}\right)$  key to switch into VFO mode.

**CH:** Channel mode, 1~22 items of function menu will hide automatically, user can only operate some functions. It is unable to switch into VFO by pressing  $\left(\frac{C}{V/M}\right)$  key. This model can be used for Amateur mode.

**NAME:** Channel+Name Tag mode, transceiver displays current channel number +channel name, press  $\left(\frac{C}{V/M}\right)$  key to switch into VFO mode.



4. Press  $\left(\frac{D}{ESC}\right)$  key or  $\left(\frac{\#}{BANK}\right)$  key to confirm and exit.

### Resume Factory Default

You can make all the settings of transceiver return to the factory default settings when transceiver can not work normally because of wrong operation or error setup.

1. Press [PF2] key to turn on radio, hold [PF2] key until transceiver emits beep.
2. Press  $\left(\frac{B}{MAIN}\right) / \left(\frac{C}{V/M}\right)$  key to choose No.02 function item, it shows "RESTOR" on LCD.
3. Rotate channel switch to choose desired setup.



## ◦ SENIOR FUNCTION OPERATIONS

**OFF:** No operations.

**FACT:** Resume all items to factory default, including channel and background settings.

**INIT:** Resume background settings to factory default, channel operations are keeping.

4. Press **[D ESC]** key to exit current selection.
5. Press **[# BANK]** key to confirm current selection.

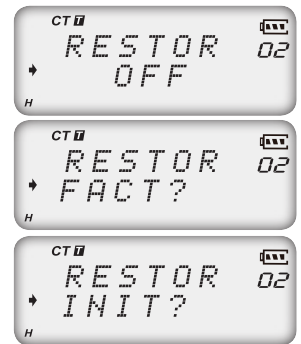

## 📶 Cloning Cable

This feature will copy the programmed data and parameters from the master unit to slave units. It copies the parameters and memory program settings.

Connection: Use optional CP04 cloning cable, connect Read/write frequency port on both master and slave, setting and programing as the requirement below.

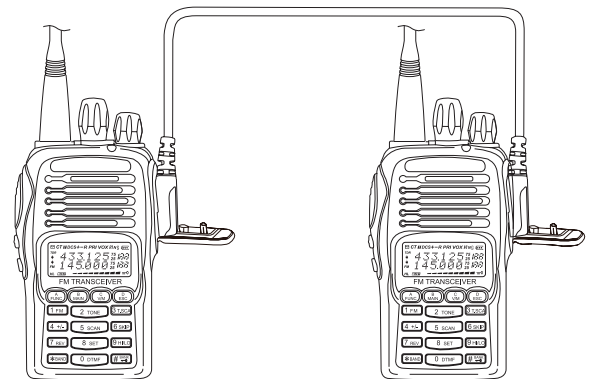

## o SENIOR FUNCTION OPERATIONS

**AnyTone**  
*We only do best radio!*

[Settings: Master side]

1. Press the [PF1] side key to Power on, the display shows "**CLONE**", the master unit enters into copy mode .
2. Press [PF1] key, the display appears "**CLONE XX**" XX stands for the data amount being cloned.
3. When the data transfer is completed, slave unit restarts, the master unit display appears "**CLONE 04**".
4. Master unit remain copy mode state to prepare for the next copy, if reboot the master means exit copy mode to return to normal mode.



CLONE



CLONE  
A5



CLONE  
04

[Settings: Slave side]

1. In the standby mode, when the slave receives the data, the display shows "**CLONE XX**" XX stands for the data being cloned.
2. When data reception is complete, the slave unit returns to normal mode and restart automatically.
3. Turn off the slave's power, remove the cable, insert another slave which you want to copy.





CLONE  
A5

If the data is not successfully transmitted, turn off the master and slave, check if the cable connections are correct, and then repeat the whole process again.

## ○ MEMORY BANK



10 memory banks 0-9 are available for 3318UV, bank 0 includes all edited channels. Bank 1-9 can be assigned maximum 32 channels, a channel can be assigned to more groups by software programming or radio itself operation.



### Assign channel to memory bank:

1. In Memory channel mode, choose a memory channel, press  key, bank number show in the channel number position as "-X" twinkling.
2. Turn Channel selector to choose desired memory bank, press  key, the memory channel will be assigned to the bank.
3. If the bank already has 32 channels, the new assigned channel will replace the last channel in bank.



## ((( Memory Bank Switch

In Channel mode, press  key twice to enter memory bank mode, press  key then press  key to enter into function menu.

1. Press  /  key to choose menu 33, LCD show "BAK--".
2. Turn Channel switch to choose bank 0--9, press  key confirm
3. Rotate the channel switch clockwise to enter into desired memory bank.



**Note: When the bank linking is on, if no channel in the selected bank, radio will enter into the next linking bank.  
When the bank linking is off, if no channel in the selected bank, current channel will be assigned to this bank.**

## ((( Memory Bank Exit

When transceiver in memory bank mode, press  key twice to exit and return to channel mode.

## ○ MEMORY BANK

**AnyTone**  
We only do best radio!

### Bank linking

1. In channel mode, press **# BANK** key twice to enter into memory bank mode, press **A FUNC** key then press **B SET** key to enter into function menu.
2. Press **B MAIN** / **C V/M** key to choose menu 34, LCD show "**BALK**".

**ON:** Turn on Bank linking.

The following menus allow adding or deleting banks.

Menu 35 BANK LINK 1 ON/OFF

Menu 36 BANK LINK 2 ON/OFF

Menu 37 BANK LINK 3 ON/OFF

Menu 38 BANK LINK 4 ON/OFF

Menu 39 BANK LINK 5 ON/OFF

Menu 40 BANK LINK 6 ON/OFF

Menu 41 BANK LINK 7 ON/OFF

Menu 42 BANK LINK 8 ON/OFF

Menu 43 BANK LINK 9 ON/OFF

Menu 44 BANK LINK 0 ON/OFF

**OFF:** Turn off Bank linking, hide menu 35-44.

When bank linking is on, one or more banks can be added into scan list. In memory bank mode, enable the scanning function, transceiver will scan the channels in current bank. During scanning, long pressing key 0-9 will add or delete the corresponding memory bank.



## ○ Programming software starting (Takes Windows XP system for example)

**AnyTone**  
*We only do best radio!*

1. Double Click "QPS3318UV\_USA setup.exe", then go on installing as computer command.
2. Click "START" menu of computer, choose "USB To COM" in QPS3318UV\_USA item and click it. Please install USB To Comport drive program as computer command.
3. Please plug PC03 programming cable into USB port of PC device, then connect to transceiver.
4. Double click "QPS3318UV\_USA" shortcut icon, or click QPS3318UV\_USA item in "START" menu to open programming software interface.
5. Choose "COM Port" as computer command, then click "OK" to start programming software.

**NOTE: In same computer, if programming cable plugs into different USB port, the COM Port number is different.**

Before programming, transceiver should be turned on firstly.

Not turn on or turn off transceiver when it is connecting with computer, otherwise it may cause transceiver not read or write data. If this situation is happened, please shut down programming software, remove programming cable from computer, then re-plug cable into computer and re-start programming software, re-choose COM Port, the programming will work normally.

### NOTE:

**The programming software is attached with product identifying system. In first time run, the transceiver should be connected to computer, otherwise the software can not run.**

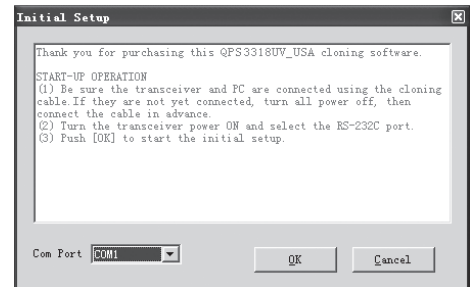

(picture 1)

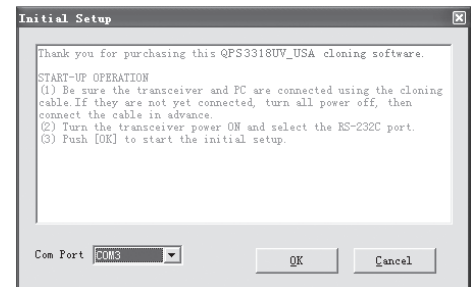

(picture 2)

## ○ TECHNICAL SPECIFICATION

**AnyTone**  
We only do best radio!

General	
Frequency Range	VHF: 136~174MHz (EX: 108~180MHz) UHF: 400~480MHz (EX: 400~520MHz)
Channel Capacity	200 channels
Channel Spacing	25KHz (wide band) 12.5KHz (narrow band)
Phase-locked Step	0.1KHz
Operation Voltage	7.4V DC $\pm$ 20%
Battery Life	More than 12 Hours(1500mAh), by 5-5-90 working cycle
Frequency Stability	$\pm$ 2.5ppm
Operation Temperature	-20°C ~ +55°C
Size	112x61x35mm (with battery)
Weight	235g (with battery)

Receiving Part		
	Wide band	Narrow band
Sensitivity (12dB SINAD)	$\leq$ 0.25 $\mu$ V	$\leq$ 0.35 $\mu$ V
Adjacent Channel Selectivity	$\geq$ 65dB	$\geq$ 60dB
Intermodulation	$\geq$ 60dB	$\geq$ 60dB
Spurious Rejection	$\geq$ 70dB	$\geq$ 70dB
Hum & Noise	$\geq$ 45dB	$\geq$ 40dB
Audio Distortion	$\leq$ 5%	
Audio Power Output	1000mW/10%	

Transmitting Part		
	Wide band	Narrow band
Power Output	VHF:5W/1W	UHF:4W/1W
Modulation	16K $\Phi$ F3E	11K $\Phi$ F3E
Adjacent Channel Power	$\geq$ 65dB	$\geq$ 60dB
Hum & Noise	$\geq$ 40dB	$\geq$ 40dB
Spurious Emission	$\leq$ -36dB	$\leq$ -36dB
Audio Distortion	$\leq$ 5%	

## ◦ TROUBLE SHOOTING GUIDE

Problem	Corrective Action
No power	A.The battery may be exhausting. Recharge or replace the battery. B.The battery may not be installed correctly. Remove the battery and install it again. C.The power switch is broken; send it to local dealers to repair. D.Battery touch is broken; send it to local dealers to repair.
Battery power dies shortly after charging.	The battery life is finished. Replace the battery pack with a new one.
Transceiver cannot scan	The channels are not in scan list. (Professionals set it.)
All band noisy after programmed	Turn on squelch when programmed. Non-professionals are advised not rammed to adjust this function.
No sound after using earphone. for a while	Earphone jack is broken. Please contact with local dealers to repair.
Communication distance becomes short, and Low sensitivity	A.Check whether the antenna is in good conduction and the antenna base do not come adrift. B.Antenna connector is broken or not or with sundries. Whether it has set in low power output. (Please contact with local dealers to repair.)
Cannot talk or hear other members in your group	A.Different frequency or channel, please change it. B.Different CTCSS/DCS/DTMF, please reset it. C.Out of communication range.

## ◦ TROUBLE SHOOTING GUIDE

**AnyTone**  
We only do best radio!

Can not power on or frequent power off	Check weather the battery touch is out of sharp or broken.
The receiving sound gets low or intermittent	Check weather the MIC is stoppage. Otherwise, please contact with local dealers to repair it.
Receiving intermittent with in big noise	A.Out of communication range or obstruct by tall buildings or in big noise. B.450 filter is broken, Please contact with local dealers to repair.
Loudspeaker become lower or with"ka ka"sound after using a certain time	Check whether the loudspeaker is broken, Iron powder or sundries is in the loudspeaker. Please contact with local dealers to repair.
Receive voice from the other party but can not transmit	Check [PTT] key.
Receiving indicator with green light but no sound	A.Low volume, please clockwise to turn on. B.Loudspeaker is broken, please contact with local dealers to repair. C.Earphone jack is broken, please contact with local dealers to repair. D.Volume switch is broken.



## o ATTACHED CHART

### ((( CTCSS Frequency Chart

1	62.5	12	94.8	23	136.5	34	177.3	45	218.1
2	67.0	13	97.4	24	141.3	35	179.9	46	225.7
3	69.3	14	100.0	25	146.2	36	183.5	47	229.1
4	71.9	15	103.5	26	151.4	37	186.2	48	233.6
5	74.4	16	107.2	27	156.7	38	189.9	49	241.8
6	77.0	17	110.9	28	159.8	39	192.8	50	250.3
7	79.7	18	114.8	29	162.2	40	196.6	51	254.1
8	82.5	19	118.8	30	165.5	41	199.5	52	user-defined
9	85.4	20	123.0	31	167.9	42	203.5		
10	88.5	21	127.3	32	171.3	43	206.5		
11	91.5	22	131.8	33	173.8	44	210.7		

o ATTACHED CHART

📶 **1024 groups DCS frequency chart**

000	001	002	003	004	005	006	007
010	011	012	013	014	015	016	017
020	021	022	023	024	025	026	027
030	031	032	033	034	035	036	037
040	041	042	043	044	045	046	047
050	051	052	053	054	055	056	057
060	061	062	063	064	065	066	067
070	071	072	073	074	075	076	077
100	101	102	103	104	105	106	107
110	111	112	113	114	115	116	117
120	121	122	123	124	125	126	127
130	131	132	133	134	135	136	137
140	141	142	143	144	145	146	147
150	151	152	153	154	155	156	157
160	161	162	163	164	165	166	167
170	171	172	173	174	175	176	177
200	201	202	203	204	205	206	207
210	211	212	213	214	215	216	217
220	221	222	223	224	225	226	227
230	231	232	233	234	235	236	237
240	241	242	243	244	245	246	247
250	251	252	253	254	255	256	257

## o ATTACHED CHART

260	261	262	263	264	265	266	267
270	271	272	273	274	275	276	277
300	301	302	303	304	305	306	307
310	311	312	313	314	315	316	317
320	321	322	323	324	325	326	327
330	331	332	333	334	335	336	337
340	341	342	343	344	345	346	347
350	351	352	353	354	355	356	357
360	361	362	363	364	365	366	367
370	371	372	373	374	375	376	377
400	401	402	403	404	405	406	407
410	411	412	413	414	415	416	417
420	421	422	423	424	425	426	427
430	431	432	433	434	435	436	437
440	441	442	443	444	445	446	447
450	451	452	453	454	455	456	457
460	461	462	463	464	465	466	467
470	471	472	473	474	475	476	477
500	501	502	503	504	505	506	507
510	511	512	513	514	515	516	517
520	521	522	523	524	525	526	527
530	531	532	533	534	535	536	537

o **ATTACHED CHART**



540	541	542	543	544	545	546	547
550	551	552	553	554	555	556	557
560	561	562	563	564	565	566	567
570	571	572	573	574	575	576	577
600	601	602	603	604	605	606	607
610	611	612	613	614	615	616	617
620	621	622	623	624	625	626	627
630	631	632	633	634	635	636	637
640	641	642	643	644	645	646	647
650	651	652	653	654	655	656	657
660	661	662	663	664	665	666	667
670	671	672	673	674	675	676	677
700	701	702	703	704	705	706	707
710	711	712	713	714	715	716	717
720	721	722	723	724	725	726	727
730	731	732	733	734	735	736	737
740	741	742	743	744	745	746	747
750	751	752	753	754	755	756	757
760	761	762	763	764	765	766	767
770	771	772	773	774	775	776	777

**NOTE: N stands for positive code. I stands for inverted code. 1024 groups of DCS in total.**